

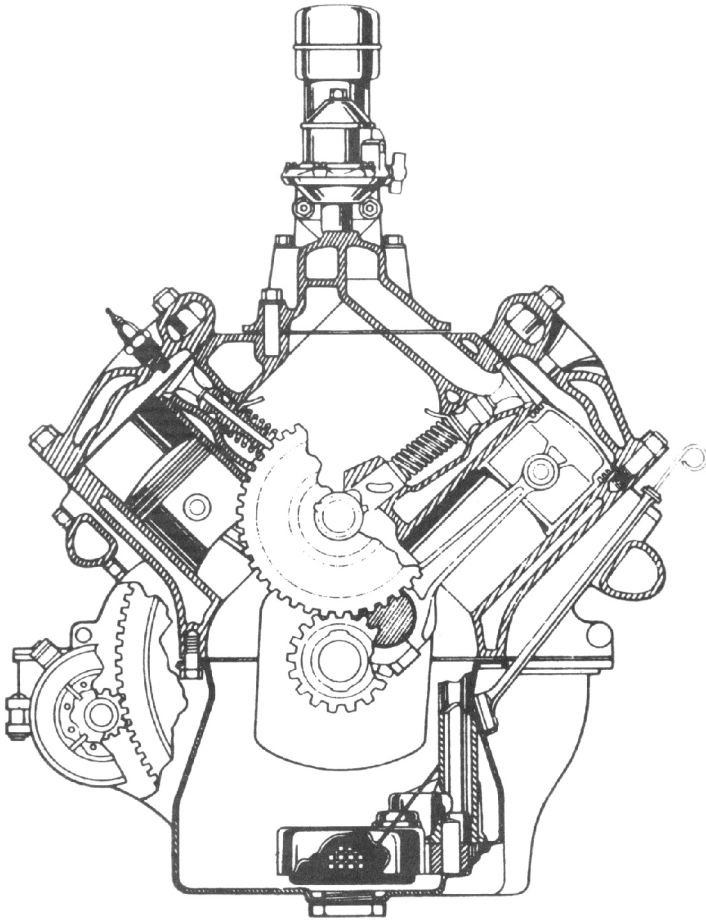

Drive Lines

Chapter #40
Our 48th Year
Visit Our Website
"valleyV8s.org"

June 2019



The Valley V8's
9700 Farralone, Chatsworth, Ca. 91311

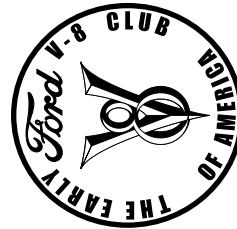

The Valley V's

2019

President	Ernie Baily	805-428-0558
Past Presidents	Vaskin Hagopian	323-661-2044
Vice President	Jim Ellerbrock	818-437-0412
Secretary	Rex Jaramillo	213-706-3854
Treasurer	Joan Sapper	818-249-5686
Tours	Kenney Sapper	818-249-5686
	RichCarter	708-567-2393
Programs	Larry Caplan	818-363-2849
	Joe DiFatta	818-700-1939
Membership	Sandrine Cutright	310-804-7790
	Oliver Calibet	818-310-8571
	Joan Sapper	818-249-5686
Drive Lines	Robert Glucksman	818-618-1395
Prize Raffle	Steve Boskovich	818-341-6876
50/50	Ken Sapper	818-380-5686
Ladies / Birthdays / Sunshine	Bobby Searl	818-353-6767
Name Badge	Karen Lehman	818-885-6938
Car of the Month	Jerry Jensen	805-491-3355
Web Master	Scott Dudrick	818-687-9836
Tech. Advisor	John Wolf	818-789-6201

Meeting: 1st Tuesday of the Month, 7:00p
 No host Dinner, Starting at 6:00p
 Rosie's BBQ & Grill, 8930 Corbin Ave.
 Northridge, Ca. 91324

Visit our Web Site: valleyv8s.org

Facebook: **Valleyv8s**

(<https://www.facebook.com/groups/579123315803014>)

Drive Lines is Published by
 The San Fernando V8's Regional Group 40
 of the Early Ford V8 Club of America
 9700 Farralone, Chatsworth, Ca. 91311

The Valley V's

Past Presidents

Jim Rowe	1971
Doug Peterson	1972
Don Durkee	1973-1974
Ed Warnock	1975
John Busk	1976
Chip Werstein	1977
Stan Misraje	1978
Bill Culp	1979
Al Spencer	1980
Larry Caplan	1981
Bob Rose	1982
Don Durkee	1983
Paul Kirk	1984
Kent Lowry	1985
Dave Sanborn	1986
John Kemmerer	1987
Dudley Ochsner	1988
Jerry Jensen	1989-1990
Joe DiFatta	1991
Chuck Shubb	1992-1993
George Richards	1994
Jerry Littner	1995
Dick Smith	1996
Chuck Mair	1997
Dennis Keene	1998
Rose Golt	1999
Don Stout	2000
Steve Boskovich	2001-2002
Joe DiFatta	2003
Wendi Potter	2004
Ken Sapper	2005-2006
Steven Batesole	2007
Harry Baker	2008-2009
Dave Bergman	2010
Randy Watson	2011-2012
Steve Boskovich	2013-2014
Stan Miller	2015
Don Durkee	2015
Vasken Hagopian	2016-2018
Ernie Baily	2019-????

"Your Ad Here"
For only \$5.00 a month,
YOU

can have your
business card ad
right here

For more details,
Please call or Email Rob at
818-882-2002, / madmodelr@aol.com
Please put "Drivelines" in the subject
Please make all payments to
"Valley V8 Club"



HELLO FELLOW MEMBERS

We would like to know more about You,
Your Car...

So, What I would like from our members is
a picture of you with your car, with a small
story. (1 Paragraph)

That way, We get to learn more about our
members, & we can put a face to a name &
car

Please make all submissions to ether
"Drivelines" at madmodelr@aol.com, or
"Drivelines" 9700 Farralone Ave.

Chatsworth, Ca. 91311

Thank You

Rob Glucksman, DL Editor

Our Next Meeting
Tues, 4 June 19

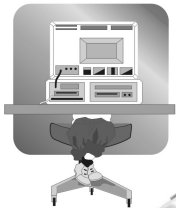

R.H.FACTOR GRAPHICS
Computer Graphics
Desktop Publishing



For all your Pre-Press needs

Robert Glucksman
Chatsworth, Ca. 91311
Office: 818-882-2002
Cell: 818-618-1395
madmodelr@aol.com



8744 REMMET AVE.
CANOGA PARK, CA 91304
(818) 998-0199
FAX (818) 341-2073

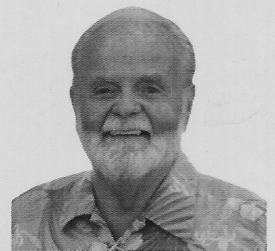

AL MOONEY
C.F.O.

al@mooneyindustries.com

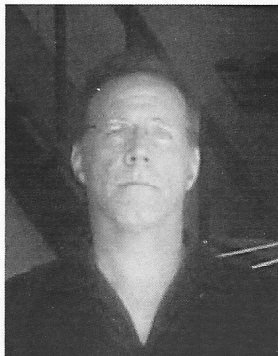

ARBONNE.
INDEPENDENT
CONSULTANT

Steven Lehman
Arbonne Independent Consultant
Consultant
23592171

Reset, Restore, Rebalance
Discover Ultimate Health,
C 818.517.1268

ArbonneForever@yahoo.com
www.stevenlehman.arbonne.com

SPEEDWAY
ENGINEERING



Ken Sapper
President
ken@1speedway.com
Office: 818.362.5865
Cell: 818.326.1286
Fax: 818.362.5608
13040 Bradley Avenue
Sylmar, CA. 91342
www.1speedway.com

CAR OF THE MONTH

Car of the Month: Went to Al Mooney with his '39 Coupe. The story is that over a year ago, past owner R. Muncy past away. Al and his son made Muncy's daughter an offer...they also got a T-Bird! They rebuilt the car, just cosmetically, as the engine was in good shape. There's more to be done. He says, "Thanks!"



Program / Speaker

PROGRAM: VP Jim Ellerbrock introduced our Speaker for tonight, Denny Todesco son of Tommy Todesco, of The Wrecking Crew band. Denny is close friends with Jim and Val. He began the program showing us a portion of a documentary made about The Wrecking Crew. Many very famous musicians shared their memories of the band. The Wrecking Crew was a professional band that numerous musicians would go to for recording their hits. Their own bands would go on the road for concerts, but were not able to actually do recording in studios.

Tommy died in 1997, and his son, Denny started working on this film. He was told by many that he couldn't do the film, but he kept going on it.

He had lots of footage from various interviews. What he needed was capital to keep project going. In 2014 they got some serious donations (some from Jim and Val!). The project was then finalized and distributed. Copies were available for sale and can be found on line as well. Hulu also has available.

A few questions from club members. Here are his answers: No he does not own a Ford. Music of the '60's had to be more perfect than it does now. Today with use of computers and technology, corrections can be made.

We thank you Denny for your program tonight! It really was good to hear those great hits of the '60's - '90's. !!



Our program for the June meeting will be presented by Ralph Hubbard. Ralph is a past Early Ford V8 Club National President and a well known Certified Appraiser of Classic Automobiles. He will give us an update on the declining prices of our Early Ford V8 cars and what is happening in the collector car market worldwide. He will also tell us about an estate sale of a very large collection of over 100 vehicles, that include many of our Early Ford cars, that he has been assigned to sell for the family His talks have always been very informative and this should be another good one.....See you there.....

Larry Caplan

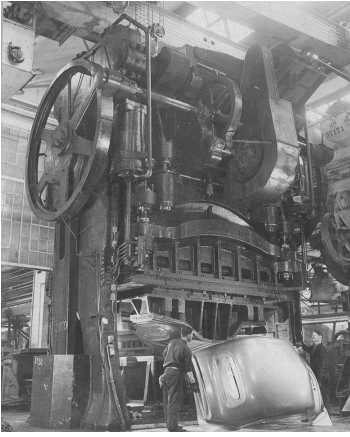

And now for some "Pressing" News

Apologies to Al Mooney, who's name was omitted from the directory. We are printing his name on a label to place in the directory

Thank You
Rob / DLE

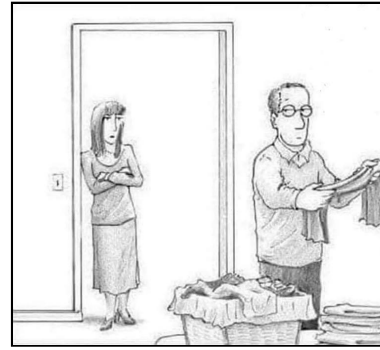

Last night you did the dishes
Today you're folding laundry
How Much Did This Latest Car Cost?

FROM THE EDITORS DESK

Hi Valley V8'ers

This is a friend of mine, Tim, & He runs a special school. He's a really good Guy, & his students have a lot to offer.

Part of what the school offers is Auto Detailing.....Check it out....Thanks, Rob / DLE

Miller Career and Transition Center is Vocational Training campus for LAUSD students with disabilities on the moderate to severe end of the spectrum. Our students did not graduate high school but are eligible for continued public education until age 22. Miller CTC focuses on teaching these students the soft skills associated with finding and maintaining a job after they leave school. We offer a variety of both classroom and community-based classes. We offer both an on campus and mobile auto detail program, landscaping/gardening, document shredding, bakery, textiles /jewelry production, and culinary arts programs. All of which offer services to the general public, giving our students an opportunity to practice the skills they are learning in a real work world environment. Anyone interested in learning more or inquiring about hiring our students can contact us at

Miller Career and Transition Center
Principal Tim Sweeney
timothy.sweeney@lausd.net
(818)885-1646
8218 Vanalden Ave. Reseda,
CA 91335-1138



MILLER
Career and Transition Center
8218 Vanalden Avenue
Reseda, California 91335

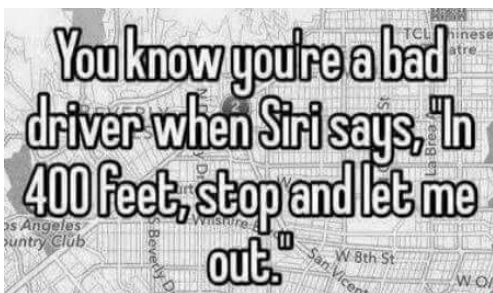

From The President

Hello All!

Well! We had a great May meeting, we celebrated Mothers Day!(Hope the ladies liked the CupCakes that my Wife made, She has really gotten into Baking and Cake decorating) Also we have Memorial Day! I plan on attending the Studebaker Meet at La Palma Park with my brothers on May 26th (I've been helping my younger brother work on his 1956 Golden Hawk and his 1964 Grand Turismo GT Hawk) and I'm going to the Clunkers Car Club Memorial day car show at the Pierce Brothers Vahalla Memorial Park at 10621 Victory Blvd. North Hollywood on May 27th. it should be fun! Also remember that June is "The Drive your V8" month. So drive your V8 to our June meeting. Also remember Fathers Day is coming up, there are a lot of car shows to take your father too or just remember your father, for me everytime I work on a Old Car I think of my Dad.

Also I was thinking it might be fun to create a "Members current Project list" which could be updated every month. Let me know if this would be of interest! I will also update the membership on the results of our May 23 Board Meeting. So if you have any ideas for speakers or tour locations, please let the board know!
See You at the June Meeting!

Ernie Baily

CHAPTER 40 -- SAN FERNANDO VALLEY V-8'S CLUB MONTHLY MEETING MINUTES FOR

May 7, 2019 Minutes of Valley V8's Club

CALL TO ORDER: President Ernie Baily began meeting at 7:00 pm with Pledge of Allegiance.

Ernie wished all the present ladies a Happy Mothers Day and presented each a beautiful flower cupcake! We thank you Diane Baily for your delicious handiwork.

REPORTS OF OFFICERS:

Secretary - Rex not present, no report.

Treasurer - Joan reported on balance and that the second payment was made to Knollwood Country Club for our annual Christmas Party (Dec. 1)

Tours - Ken announced the following:

June 1, Farmers Market;

June 15-16, Pomona Fairgrounds Fathers Day weekend LA Roadster Show.

June 23, La Palma Park '40 Fords;

June 29, Iskenderian Cams, Details / Flyer to Follow....

July 26, Simi Valley Train Station, Details / Flyer to Follow....

Membership: Oliver reported all is good and has new Roster available. Call Oliver (818-310-8571) if you didn't get your copy.

Break Time was called.

7:40 - Pres. Ernie recapped the car show at the Live Steamers Day, in Griffith Park on April 28. In attendance for our club was Ernie ('55 Dodge), John and Lin Kemmerer ('40 Deluxe Coupe), Ken and Joan Sapper ('27 Ford Track-T). Highlights were the Walt Disney Barn and the steam engine rides. He hopes more members will attend next year.

Car of the Month: Went to Al Mooney with his '39 Coupe.

Ladies Raffles: Karen Lehman and Judy Shubb. May birthdays were announced by Bobbie Searl

Name Badge winner: Vasken Hagopian

50/50: Heather (John Fredricks lady-friend)

PROGRAM: VP Jim Ellerbrock introduced our Speaker for the night, Renny Todesco, son of Tommy Todesco, of The Wrecking Crew band.

Raffle: by Steve Boskovich

Next Meeting will be June 4th.

Meeting Closed at 8:30 pm by President Ernie