

The Valley V's

2018

President	Vaskin Hagopian	323-661-2044
Past Presidents	Don Durkee	
	Stan Miller	818-360-4812
Vice President	Steve Lehman	818-885-6938
Secretary	Rex Jaramillo	818-254-8452
Treasurer	Joan Sapper	818-249-5686
Tours	Kenney Sapper	818-249-5686
	RichCarter	708-567-2393
Programs	Larry Caplan	818-363-2849
	Joe DiFatta	818-700-1939
Membership	Harry Baker	818-632-9017
	Joan Sapper	818-249-5686
Drive Lines	Robert Glucksman	818-618-1395
	Jim Kelley	310-795-0704
Prize Raffle	Steve Boskovich	818-341-6876
50/50	Ken Sapper	818-380-5686
Ladies / Birthdays / Sunshine	Bobby Searl	818-353-6767
Name Badge	Karen Lehman	818-885-6938
Car of the Month	Jerry Jensen	805-491-3355
Web Master	Scott Dudrick	818-687-9836
Tech. Advisor	John Wolf	818-789-6201

Meeting: 1st Tuesday of the Month, 7:00p
No host Dinner, Starting at 6:00p
Rosie's BBQ & Grill, 8930 Corbin Ave.
Northridge, Ca. 91324

Visit our Web Site: valleyv8s.org

Drive Lines is Published by
The San Fernando V8's Regional Group 40
of the Early Ford V8 Club of America
9700 Farralone, Chatsworth, Ca. 91311

The Valley V's

Past Presidents

Jim Rowe	1971
Doug Peterson	1972
Don Durkee	1973-1974
Ed Warnock	1975
John Busk	1976
Chip Werstein	1977
Stan Misraje	1978
Bill Culp	1979
Al Spencer	1980
Larry Caplan	1981
Bob Rose	1982
Don Durkee	1983
Paul Kirk	1984
Kent Lowry	1985
Dave Sanborn	1986
John Kemmerer	1987
Dudley Ochsner	1988
Jerry Jensen	1989-1990
Joe DiFatta	1991
Chuck Shubb	1992-1993
George Richards	1994
Jerry Littner	1995
Dick Smith	1996
Chuck Mair	1997
Dennie Keene	1998
Rose Golt	1999
Don Stout	2000
Steve Boskovich	2001-2002
Joe DiFatta	2003
Wendi Potter	2004
Ken Sapper	2005-2006
Stever Batesole	2007
Harry Baker	2008-2009
Dave Bergman	2010
Randy Watson	2011-2012
Steve Boskovich	2013-2014
Stan Miller	2015
Don Durkee	2015
Vasken Hagopian	2016-2018



Drive Lines

Chapter #40
Our 47th Year
Visit Our Website
"valleyV8s.org"

April 2018

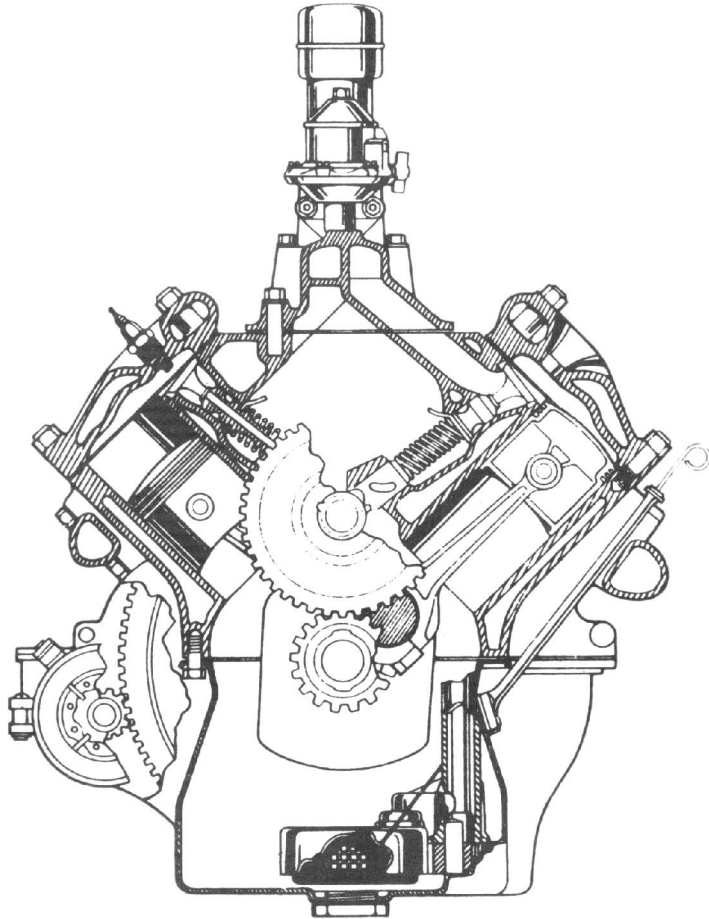

The Valley V8's
9700 Farralone, Chatsworth, Ca. 91311

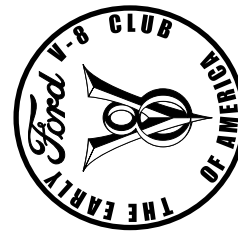

Hello Fellow Members...

We would like to know more about You, Your Car...

So, What I would like from our members is a picture of you with your car, with a small story. (1 Paragraph)

That way, We get to learn more about our members, & we can put a face to a name & car

Please make all submissions to ether

"Drivelines" at madmodelr@aol.com, or

"Drivelines" 9700 Farralone Ave. Chatsworth, Ca. 91311

Thank You

Rob Glucksman, DL Editor

Car of the Month:

Ron Batesole and his clean 1935 Ford coupe took top honors for Car of the Month. Back in 1975, Ron was browsing the LA Times Classified, and saw the '35 advertised. He drove to Sylmar to have a look, liked what he saw, and bought it. The Ford was sold new at Boyd Gibbons Ford in Los Angeles. It was very original, wasn't hot rodded or cut up. Ron even found a receipt for some maintenance work done in 1941. It did have a later 59AB engine and juice brakes, but it was stock otherwise. So Ron cleaned it up a bit and drove it that way for a few years. Then in 1980 he parked it and did a restoration. He installed an original 21-stud engine rebuilt by H & H Automotive Engine Company, and replaced the juice brakes with the stock mechanicals. Hey, those mechanical binders, when adjusted and lubed properly, can lock 'em up on a hard stop! For the re-paint, Ron used a professional old-school Binks spray gun and shot it in his driveway. He used the original Ford 'Light Gunmetal Gray' in acrylic lacquer, then color sanded and buffed it to a mirror finish. And to finish it off, Ron installed a new LeBaron Bonney interior. We're telling you, he's a real do-it-yourselfer! To make this coupe really stand out, Ron changed the deck lid from original trunk to rumble seat, how swell is that! Most recently, he replaced the old carburetor with a brand new Stromberg 97. Yep, this Ford is built for driving. With a Columbia 2-speed rear end to keep the engine revs down, this cool coupe cruises easily down the road. Nice work, Ron, congratulations on a job well done!



April 3rd Meeting

Our speaker will be Erin Gershik, A fellow Car enthusiast

She will be discussing the horrors of restoring her car

Bring a Guest, See you on the 3th



Gil's MUFFLER

NOW IN MOORPARK!
 476 #B2 W. Los Angeles Ave. Moorpark, CA 93021
INSIDE CHRIS' AUTO CONNECTION

Dale Schirmeister (818) 885-8867
CALL FOR AN APPOINTMENT

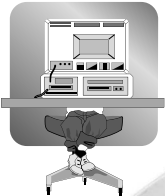

R.H.FACTOR GRAPHICS
*Computer Graphics
 Desktop Publishing*

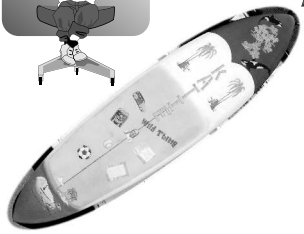

Robert Glucksman
 Chatsworth, Ca. 91311
 Office: 818-882-2002
 Cell: 818-618-1395
 madmodelr@aol.com

For all your Pre-Press needs

**SPEEDWAY
 ENGINEERING**



Ken Sapper
 President
 ken@1speedway.com
 Office: 818.362.5865
 Cell: 818.326.1286
 Fax: 818.362.5608
 13040 Bradley Avenue
 Sylmar, CA. 91342
 www.1speedway.com

"Your Ad Here"
For only \$5.00 a month,
YOU
 can have your
 business card ad
 right here



For more details,
 Please call or Email Rob at
818-882-2002, / madmodelr@aol.com
 Please put "Drivelines" in the subject
 Please make all payments to
"Valley V8 Club"

Chapter 40 -- San Fernando Valley V-8's Club

Monthly Meeting Minutes for Tuesday Mar. 6, 2018

7:00 pm: Meeting called to order.

President Vasken Hagopian led us in the Pledge of Allegiance. He then welcomed the group to the meeting.

Guest Introductions

The following were introduced:

Guest speaker Tony DeFrank from California Car Cover, Brandon Jacobson, also from California Car Cover, and Fay Mayo, guest of her grandparents Gerald and Pamela Buck. Then Joe DiFatta made a most excellent announcement:

Brandon Jacobson, long-time guest-attender, joined our club this evening. Congratulations, Brandon and welcome aboard!

Opening Comments by our President:

Daylight Savings! On Sunday morning (better, Saturday evening), turn your clocks 'Spring' forward.

Club Name Badges: Karen Lehman, our Club Name Badge Raffle Coordinator, only collected \$1.50 worth of quarters from members who didn't bring their badges, not too bad. Members, keep wearing 'em!

Free gas tank: Vasken offered up the old gas tank from his '34 Ford, call him!

San Antonio Brewery Tour: Rich Carter discussed the upcoming Tour, scheduled for March 30. The Winery is celebrating its 100 year anniversary. Rich and Lynn are doing a great job setting it up. And if you drive your old Ford in, you'll have special parking, how swell is that! Plan to arrive around 11 am for a little hangin' out-time beforehand. There's a gift shop to browse, and a wine tasting room. At 11:45 we'll get in line for lunch, it'll cost \$10 to \$20 plus tax & tip. Then at 1 pm we'll be offered a guided tour of the winery, an amazing and very informative activity. Rich and Lynn have 25 signed up so far. Thanks, Carters, for setting this up for us!

Upcoming Activities: Vasken announced upcoming car shows and events:

April 7 (Saturday) Coffee n Kix, Don Stouts, 22500 Itasca, Chatsworth

April 29 (Sunday) 18th Annual Burbank Kiwanis For Fun Car Show, Johnny Carson Park, Burbank.

May 6 (Sunday) Cars for Cops Car Show, Verdugo Park, Glendale.

May 20 (Sunday) Cal Rods Car Show, Santa Anita Racetrack, Arcadia. Here's a good one:

June 16 Saturday has been designated by The Early Ford V-8 Club, National, as 'Drive Your V-8 Day'. As a preliminary and fun activity, we're encouraged to drive our old Fords to the V-8 Club meeting here on Tuesday, June 5.

Drivelines Newsletter: Robert Glucksman, Editor, reminded us about the swell deal being offered: For \$5, you can have your business card advertised in the Drivelines Newsletter. Call Robert for more info.

Reports from Officers:

Secretary's report: Rex Jaramillo Everything OK.

Treasurer's report: Joan Sapper Everything OK, gave monthly report.

Editor's report: Robert Glucksman -- Everything OK.

Membership report: Harry Baker Announced that 16 members haven't paid yet, he mentioned he'd be calling them. Jerry Littner, prior Membership Coordinator, stood and gently coaxed the non-paid members, kindly urging them to 'pay up'.

Tours report: Rich and Lynn Carter Upcoming Winery Tour still on track and scheduled for Friday, March 30.

7:25 pm: Break called

7:50 pm: Meeting resumed

Car of the Month:

Ron Batesole and his clean 1935 Ford coupe took top honors for Car of the Month.

And now for some
"Pressing" News
 Some new laws.....



SB 1 & AB 1

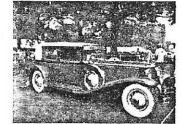

These are California State Bills SB 1 & AB 1

- Vehicles with a vehicle market value range between (\$0) and (\$4,999), a fee of twenty-five dollars (\$25).
- Vehicles with a vehicle market value range between (\$5,000) and (\$24,999), a fee of fifty dollars (\$50).
- Vehicles with a vehicle market value range between (\$25,000) and (\$34,999), a fee of one hundred dollars (\$100).
- Vehicles with a vehicle market value range between (\$35,000) and (\$59,999), a fee of one hundred fifty dollars (\$150).
- Vehicles with a vehicle market value range of (\$60,000) and higher, a fee of one hundred seventy-five dollars (\$175).

The above fees will be due in addition to an approx 43% fuel tax increase and \$38.00 vehicle registration fee increase. These additional taxes and fees will cost the average motorists over \$400.00 per year per vehicle. Plus add to the cost of Gas 16 cents, Diesel 20 cents. Both of these bills, if passed into law, would increase the weight fee on all trucks.

For further information go to, <http://leginfo.legislature.ca.gov/faces/home.xhtml>

Contact:

Senator Steven Bradford	Fresno, Oakdale, and surrounding areas	Ph. 916 651 4035
Assemblyman Mike Gipson	Gardena and surrounding area's	Ph. 916 651 2064
Assemblyman Tony Thurmond	Oakland and surrounding area's	Ph. 916 319 2015
Assemblyman Tom Daly	Anaheim and surrounding area's	Ph. 916 319 2069
Assemblyman Adam Gray	Merced & Modesto, surrounding area's	Ph. 916 319 2021
Assemblyman Jim Cooper	Elk Grove and surrounding area's	Ph. 916 319 2009
Assemblyman Rudy Salas	Bakersfield and surrounding area's	Ph. 916 319 2032

SB 640 Would tax services, presently there in no tax on services.

Ab 1640 Would take from transportation funds and would give back to low income communities.

SB 54 Would make California a "Sanctuary State"

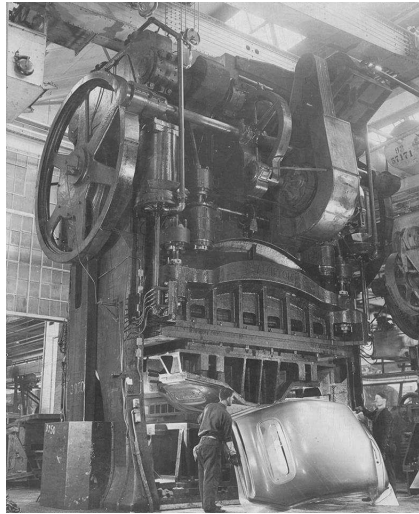

Gil & Dale, Long time friend to the Hot Rod & Vintage Car Owner, Is now in Moorpark

Gil's MUFFLER
NOW IN MOORPARK!
 476 #B2 W. Los Angeles Ave. Moorpark, CA 93021
INSIDE CHRIS' AUTO CONNECTION
Dale Schirmeister (818) 885-8867
CALL FOR AN APPOINTMENT

Hello Fellow V8'ers
Mr. Chuck Rice is selling his 39 Ford



This is a 1939 Ford Tudor Deluxe, I have \$12,500 invested, engine machine work is complete. The 8ba motor has been bored 30 over, the crank has been ground 10 under and it has been machine for 1.5" valves in and out. I also have about \$3000 in brand new engine parts as well as all the old stock I took off. More pictures can be sent on request asking \$8000.

Chuck Rice (818)-768-4025.

From the President.

Happy Easter.

March was an interesting month, with all the holidays, and all the fun we had with a full house of members at our meeting.

Mr. Tony Frank from California car covers gave us a good lecture on car covers, the quality, and the types. He also gave us the family history on how this wonderful, and a successful company started.

April is a month to pay your property taxes on the 10th, and income tax on the 15th, depending if you pay or receive?

It was good to see Harry and Helen to come to Los Angeles to thaw out from the frozen tundra.

Harry will be collecting the membership dues for the year. It makes it hard for the board of directors to keep tabs on unpaid members. Please do not drag your membership dues to the middle of the year. If you have not paid your dues by the time the membership directory is printed, you are too late for the year, and will not get a directory.

Robert volunteered to follow up on the CP.R. hands on instructor to demonstrate to our club.

April 7th is our first coffee and kicks at Don's, lets get out there and kick some

Reminding you!!! .25 cents if you forget your name badge, we collected a walloping \$1.50 last month. Can the lotto guarantee this?

I want to thank the Board of directors for doing an outstanding job. Our meetings run very smooth, because each board member that has an assigned duty, has done his or her job before coming to the meeting.

Being a member in many other car clubs, I have seen the decline in membership due to health and age. Please put an effort to bring a friend to our meeting, let us work on increasing our membership.

Happy Easter.

Vasken Hagopian

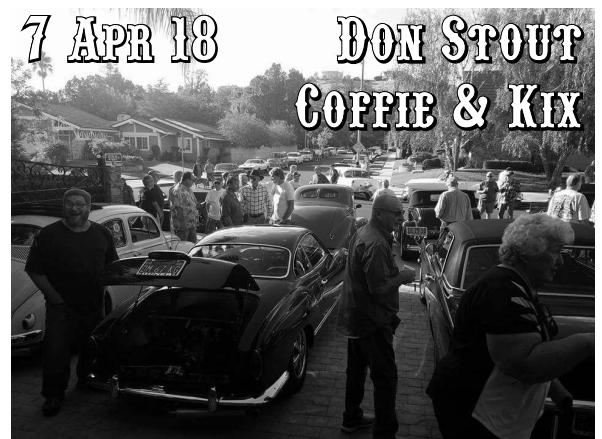

(Monthly Meeting Minutes Continued)

Ladies Raffle: Handled by Bobbie Searle, won by Helen Baker and Nancy Wardell.

Birthday's for March: Handled by Bobbie Searl. Happy Birthday to Harry Baker, Robert Glucksman, Phil Hall, Connie Hall, Dennis Keene, Ruth Mottern, Dick Stones, and Ed Warnock.

Name Badge Raffle: Handled by Karen Lehman. Won by Rex Jaramillo.

50/50 Raffle: Handled by Ken Sapper. Won by Brandon Jacobson.

Prize Raffle: Handled by Joe DiFatta. Won by many grateful Club members.

Program:

Joe DiFatta introduced Tony DeFrank from California Car Cover. Tony and brother Jimmy are involved in most of the day-to-day operations, with Tony being the marketing guy. The Company was founded by Mom and Dad, Jim and Loraine DeFrank, who are still heavily involved in the Business. Jim grew up in Pittsburgh and spent most of his growing-up years at car shows and drag strips. In 1965 the couple, newlyweds at the time, packed up their '55 Chevy and moved to Southern California. Jim had various other related jobs before opening California Car Cover in 1989. It started as a small mail-order business in Van Nuys with a four page catalog of custom fit car covers and accessories. California Car Cover is still family owned and operated, however is significantly larger. Now they have over 40 people, half of their business is over the phone, 40% on-line orders, and 10 % is showroom business. Their catalog is now over 70 pages and carries related products of everything it takes for car guys 'n gals to maintain their vehicles. The Company is a strong supporter of classic car shows and NHRA drag racing events around the country. And they have a number of local car shows at their facility in Northridge throughout the year and are involved with fund-raisers for local charities. Tony spoke about their product line, then talked about some of the technology and manufacturing processes. Then he shared information about washing their car covers. Generally, using a mild detergent then allowing the cover to air dry vs. machine dry is the way to go. Then our very own Ed Warnock shared his background about being an employee at California Car Cover, small world! In closing, Tony introduced Brandon Jacobson, Showroom Manager of California Car Cover and latest member of our V-8 Club. He then offered our Club members 10% discount this next month on any of their products. A most excellent presentation, Tony, thanks for sharing!



8:35 pm: Meeting adjourned. Next meeting Tuesday April 3.

Minutes submitted by Rex Jaramillo

NEW MEMBER

Brandon Jacobson, long-time guest-attender, joined our club this evening. Congratulations, Brandon and welcome aboard!

Let Me tell you about this "KID"... Brandon Is an awesome person.

I have known him since before he could drive on his own, Driving His killer car with His Dad.

He is a well manered young Man that truely embraces the "50's". He even does much of the work on his ride

I for one am Proud to have him as a new member

"Ride Well" My Friend

